

PART NO.:  
B05-009NNBN6-XXC

ENTRY HOLE SIZES:  
55: OD 5.5mm  
65: OD 6.5mm  
80: OD 8.0mm

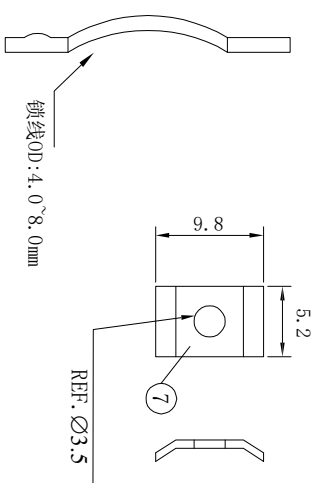
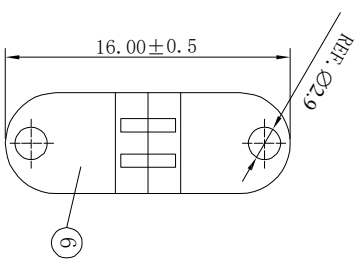
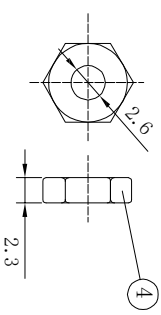
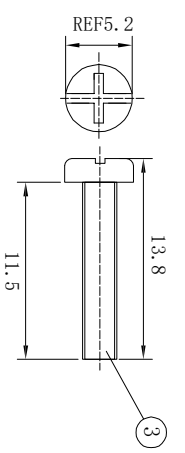
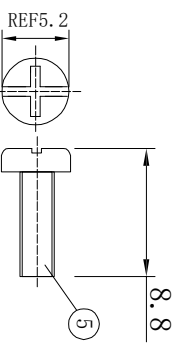
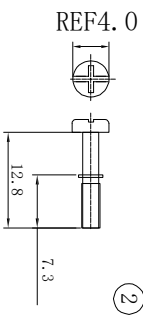
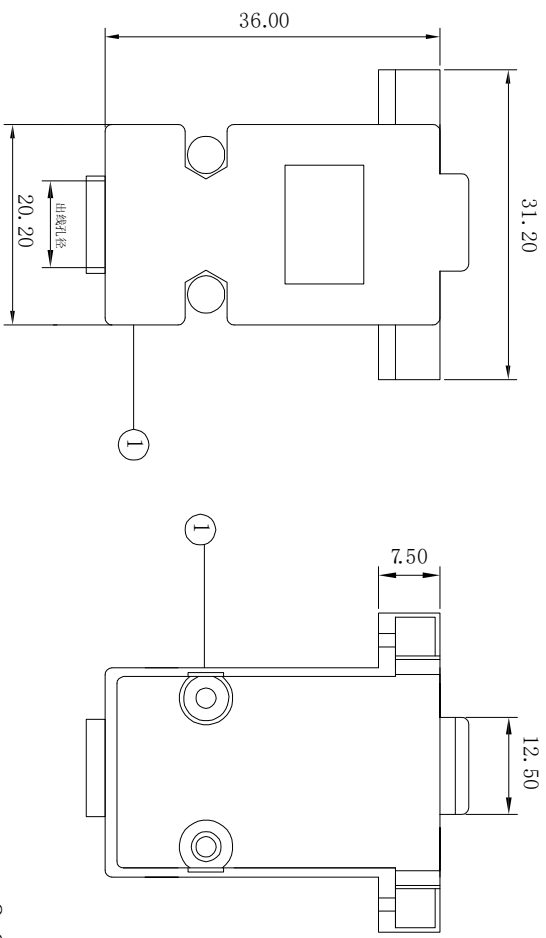

ITEM	DESC.	MATERIAL	REMARKS	PART REMARKS
1	上下外壳	ABS	PLATING:Cr	1SET
2	半牙螺丝#40	快削铁	PLATING:Ni	2PCS
3	固定螺丝M3	快削铁	PLATING:Ni	2PCS
4	固定螺母M3	快削铁	PLATING:Ni	2PCS
5	线夹螺丝M3	快削铁	PLATING:Ni	2PCS
6	线夹	SPPC	PLATING:Ni	2PCS
7	垫片	SPPC	PLATING:Ni	2PCS

PART NAME: D-SUB 9P(HDB 15P(H)ABS Hood (Plating Cr) PART NO: B05-009NNBN6-XXC

QUALITY SYMBOLS  
 : Tolerance  
 : CRITICAL  
 : MAJOR  
 : ZERO DEFECT  
 : S.P.C

REV: A  
 SCALE: N:1  
 DATE: 2018/03/11  
 DRW BY: Huangmei  
 CHK BY: Jack Chen  
 APP BY: Jack Chen  
 DRAWING NO: B05-009

Kinkuo  
 东莞市箐国电子有限公司  
 www.kinkuo.com

DATE	2018/03/11	DESCRIPTION	NEW ISSUE	APPROVER	Jack Chen
SIDE	8	DATE	7	DESCRIPTION	6